

Dashed lines/components and earthing system are not included in the delivery from Enequi

Main supply voltage 400VAC
32A lcc 6kA 400VAC max 10A

230VAC
max 10A

Internet

400VAC
20A

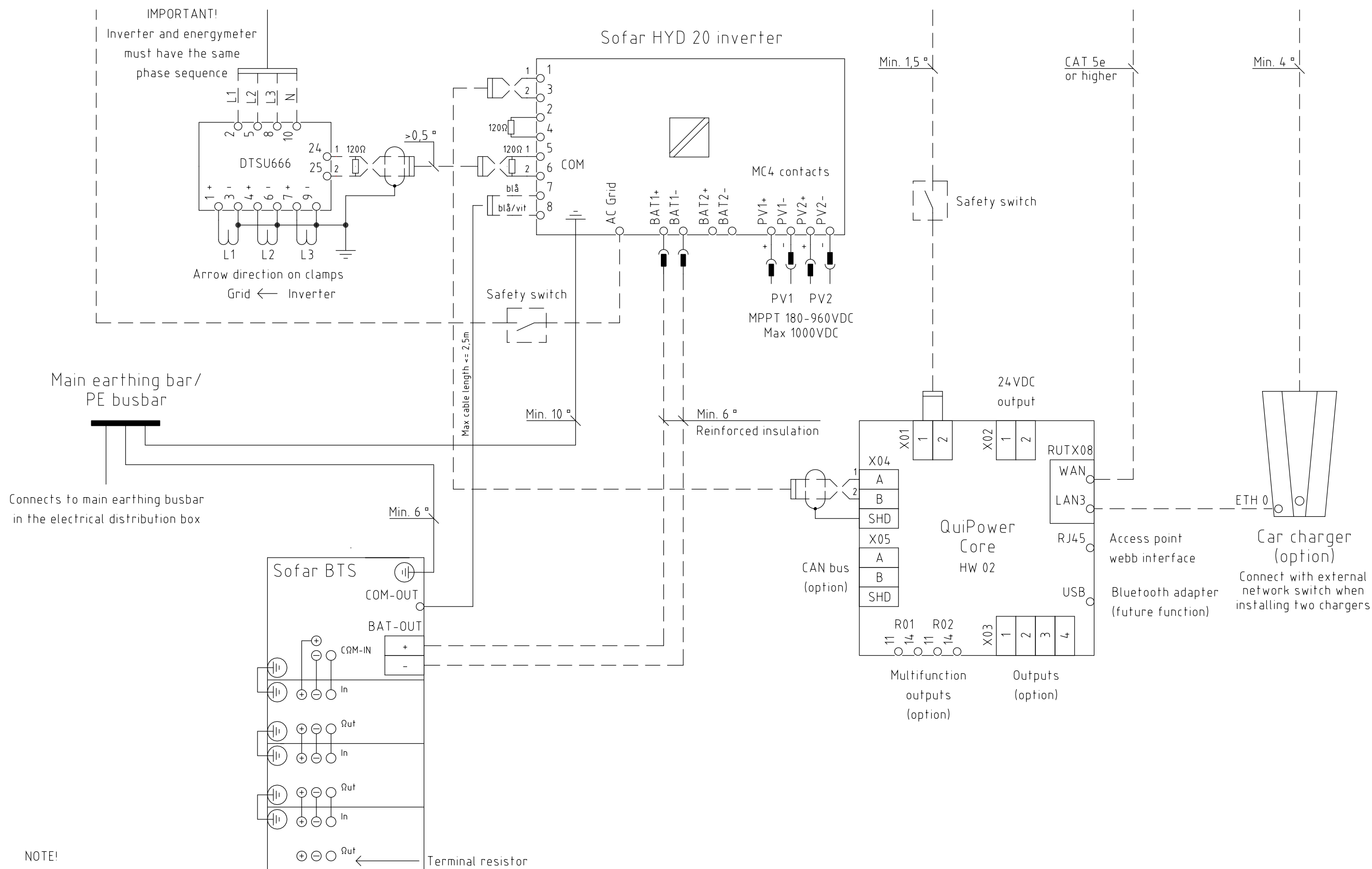

NOTE!

The system installation must, in addition to the electrical installation rules, comply with the requirements according to the standards for electrical energy storage systems (EES) TS 62933-5-1 and EN IEC 62933-5-2

R4	Texts + earth RS485	JJ	230919
R3	Terminal resistors	JJ	230706
R2	HW core	JJ	230302
NR.	ÄNDRING	SIGN.	DATUM



Enequi
BTS 5K Sofar HYD 20
System

KONSTR. AV J.J.	FILNAMN	RITNINGSNUMMER 3-820282E	
DATUM 2023-03-13	REV. R4	FORTS.	BLAD 282E

Direct measuring energy meter (option)

Order item, article number: 300581

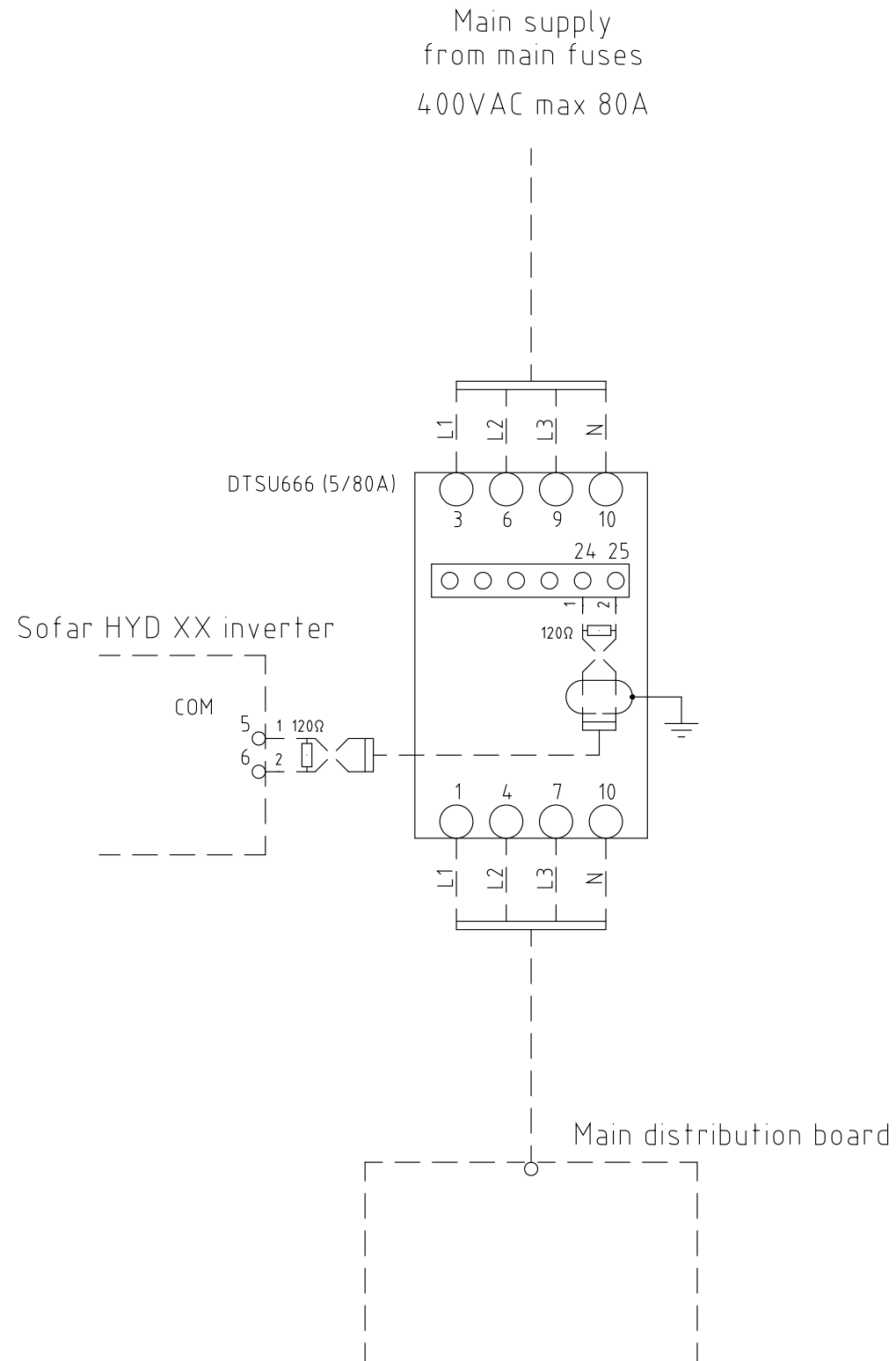

Denna ritning förblir vår egendom. Allt utan
 medgivande mångfaldiga, förewisa, utlämna
 eller obehörigen använda densamma är
 förbjudet och beivras enligt lag.

R2	Terminal resistors	JJ	230706
NR.	ÄNDRING	SIGN.	DATUM



Enequi

Direct measuring energy meter

DTSU666 (5/80A)

KONSTR. AV J.J.	FILNAMN	RITNINGSNUMMER 3-820296E	
DATUM 2023-03-07	REV. R2	FORTS.	BLAD 296E